

iMAG 4700p

Municipal/Industrial Magmeter Instructions



iMAG 4700p

General Information

General Information Page 3
 Features Page 3
 Specifications Page 4
 Dimensions Page 5
 Accuracy Page 6
 Flow Rate Page 6

Installation

Straight Pipe Recommendations Page 7
 Full Pipe Recommendations Page 8
 Positioning the Meter Page 9
 Installing Gaskets Page 9
 Tightening Flange Bolts Page 10
 Equalization and Grounding (Metal and Plastic Pipe) Page 10

Connections

General Cable Information Page 11
 Cable Gland Opening and Sealing Page 11
 Cable Installation Page 12
 Wiring Diagrams Page 13
 Cable Wiring Table Page 15

Configuration

Sourcing Mode Output Application Page 16
 Sinking Mode Output Application Page 16
 Analog (4-20mA Current Loop) Output Application Page 16
 Cable Shield Page 17
 Pulse Output Page 18
 Analog (4-20mA) Output Page 18
 Modbus Output Page 18
 Digital Output Page 18

Operation

Changing Flow Meter Settings - Home Screen and General Navigation Page 19
 Changing Flow Meter Settings - Changing Total Direction/Resetting Totalizers Page 19
 Changing Flow Meter Settings - Entering Menu System Page 19
 Changing Flow Meter Settings - Making Selections Page 19
 Changing Flow Meter Settings - Standard Menu Options Page 20
 Changing Flow Meter Settings - Special Submenu Page 20
 To Change a Passcode Page 21
 Power Indicators Page 22

Troubleshooting & Error Messages

Problem Page 23
 Probable Cause Page 23
 Things to Try Page 23
 Error Messages Page 23

Warranty

Seametrics Limited Warranty Back

Note: These instructions cover the iMAG 4700p For details on the iMAG 4700 or 4700r, see the *iMAG 4700* or *iMAG 4700r Municipal/Industrial Magmeter Instructions*.

The **iMAG-Series** are the most economical flanged electromagnetic flowmeters on the market. With electrodes designed to discourage fouling, it is available in 2" to 12" pipe in municipal or industrial water, waste and reclaimed water, pump stations, and packaged plant applications. Minimal straight pipe requirements allow iMAG-Series meters to be used in piping configurations where there is little space between the meter and an elbow.

iMAG-Series meters are CE certified, certified to NSF/ANSI standard 61 and are rated IP68 for applications where the meter may be operated under water to a depth of at least 10 feet (3 meters) continuously.

Both rate and total indication are standard. Rate and total units and pulse scaling can be set via the front panel touch key pad by the user. Bidirectional flow reading is standard with totals available in forward, reverse, net flow, batch forward flow, and batch reverse flow. Built-in data logging is available as an option for secure flow logging.

A power/output cable allows outputs for use with a variety of Seametrics and other displays and controls for remote reading and telemetry applications. Pulse output and 4-20mA passive current loop are standard on all units. Additionally, high speed digital, and Modbus® protocol outputs are optional. The iMAG 4700p can be supplied with an optional internal AC power supply.

Features

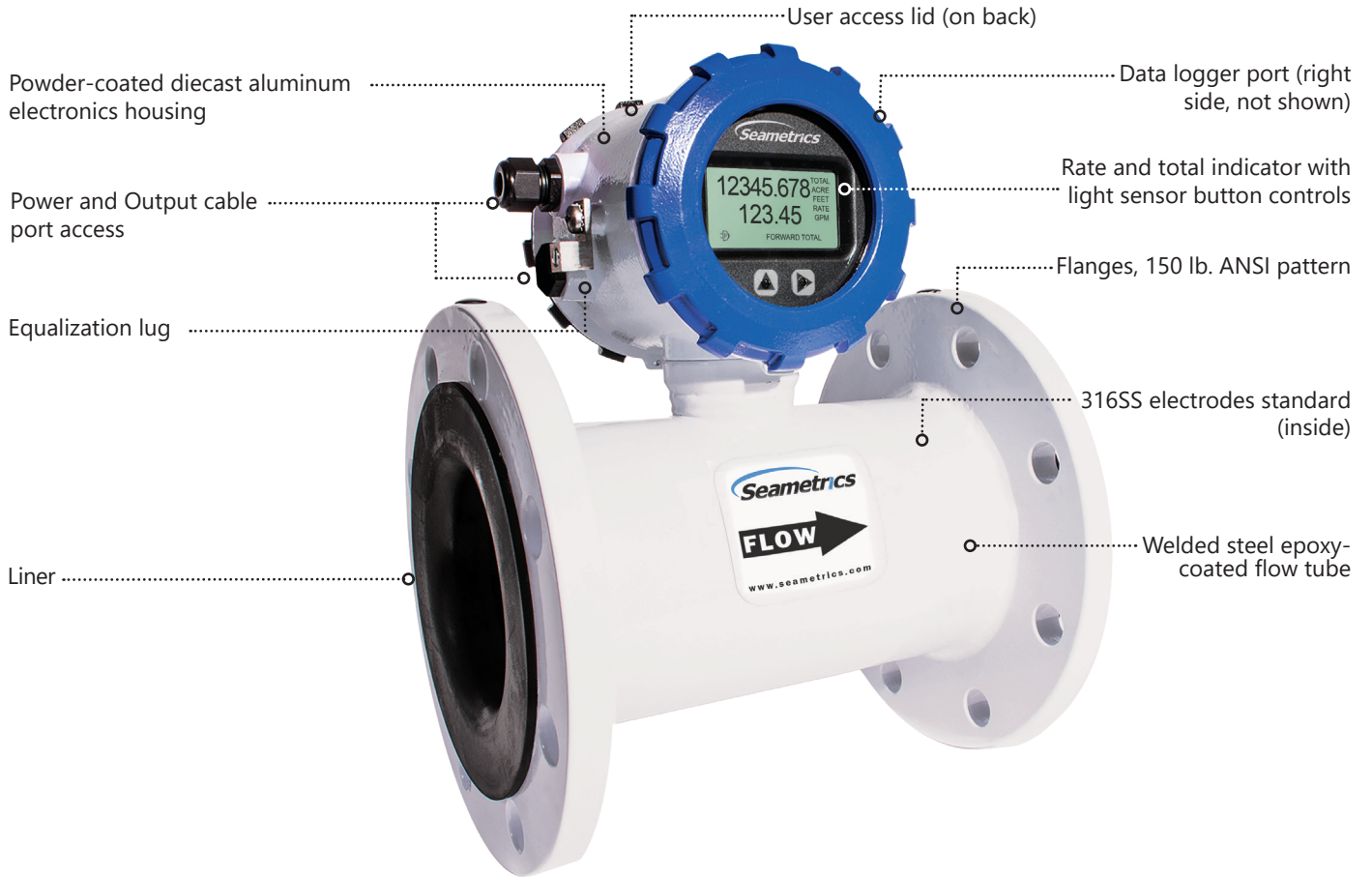

No moving parts

Specifications*

Pipe Sizes	2", 3", 4", 6", 8", 10", 12"						
Flanges	150 lb. ANSI Pattern						
Pressure	150 psi (10.3 bar) line pressure						
Temperature	Operating 10° to 140° F (-12° to 60° C)						
	Storage -40° to 158° F (-40° to 70° C)						
Accuracy	±0.75% of reading on iMAG 4700p and 4700r (±1.0% iMAG 4700), ±0.025% of full-scale flow from low flow cutoff to maxi. flow rate of 10 m/sec						
Low Flow Cutoff	0.5% of maximum flow rate						
Material	Body	Welded steel, epoxy-coated					
	Liner	Polyurethane/Noryl®					
	Electronics Housing	Powder-coated diecast aluminum					
	Electrodes	316 stainless steel standard/ Hastelloy optional					
Display	Type	128x64 dot-matrix LCD					
	Digits	5 Digit Rate			8 Digit Total		
	Units	Rate Volume Units		Rate Time Units	Total Volume Units		
	<i>Please Note: All iMAG meters are factory set for gallons per minute (GPM) rate and gallons total. If other units are required, they can be set in the field.</i>	Gallons Liters Barrels(42 gal) Cubic Feet Cubic Meters	Million Gallons ² Mega Liters ² Imperial Gallons Million Imperial Gallons ²	Second Minute Hour Day	Gallons Gallons x 10 Gallons x 100 Gallons x 1000 Million Gallons Liters Kilo Liters Mega Liters	Barrels (42 gal) Cubic Meters Cubic Meters x 1000 Cubic Feet Cubic Feet x 100 Cubic Feet x 1000 Second Foot Day Million Cubic Feet	Acre Feet Acre Inches Imperial Gallons Imperial Gallons x 1000 Million Imperial Gallons Gallons Fluid Ounces
	Bidirectional¹	Forward Total, Reverse Total, Net Total, Batch Forward Total, Batch Reverse Total ³					
Power	DC Power	9-36 Vdc @ 250 mA max, 30 mA average					
	Battery Backup <i>(Not for use as primary power)</i>	DC powered units: One lithium 7.2V 'D' size battery pack, replaceable. AC powered units: One 9V alkaline battery, replaceable.					
	AC Power	100-240Vac, 50/60Hz, 0.12A (iMAG 4700r and 4700p only)					
Scaled Pulse Output	Signal	Current sinking pulse, isolated, 36 Vdc at 10 mA max					
	Pulse Rates	User-scalable from 0.1 to 99,999.9 volume units/pulse. Pulse width is one-half of pulse period with minimum pulse width of 2.5 ms, 200 pulses/sec max. For battery option meters, pulse width varies with frequency, 150 pulses/sec max.					
Options	4-20mA Current Loop	Isolated, passive, 24Vdc, 650 Ω maximum current loop					
	High Speed Digital	Isolated, open collector, 24 Vdc (iMAG4700p only)					
	Serial Communications	Isolated, asynchronous serial RS485, Modbus® RTU protocol					
	Sensus Smart Output	Connects to Sensus SmartPoint 510M					
Cable	Power/Output Cable	20ft (6m) standard length polyurethane jacketed cable—for power and outputs (lengths up to 200' available).					
	Remote Display Cable	20ft (6m) standard length polyurethane jacketed cable—for connection between meter and remote display (lengths up to 200' available). (iMAG 4700r)					
Conductivity	>20 microSiemens/cm						
Empty Pipe Detection	Hardware/software, conductivity-based						
Regulatory	CE (EN 61326), certified to NSF/ANSI standard 61 60°C (140°F), CSA/CUS 						
Environmental	NEMA 6P, IP68 (10ft (3m) depth, continuously)						

Modbus is a registered trademark of Schneider Electric.

* Specifications subject to change. Please consult our website for the most current data (www.seametrics.com).

¹ If forward and reverse flow data needs to be sent to another device, either the Digital or Modbus output is required.

² Rate Time Unit is available in Day only.

³ Forward and reverse flow totals are non-resettable. Batch forward and batch reverse totals can be reset.

Dimensions

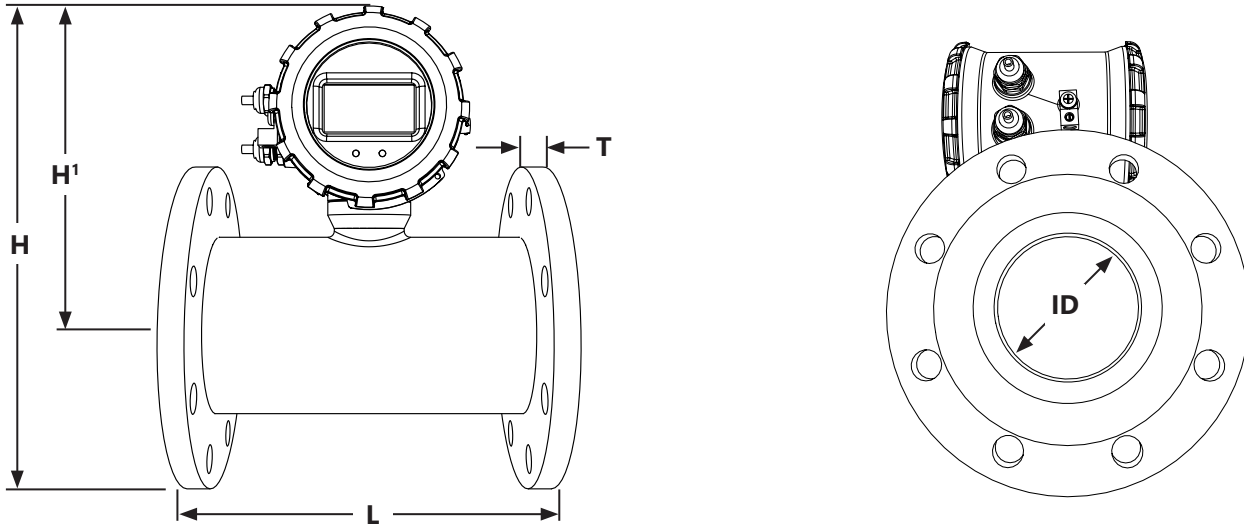

iMAG 4700 Meter Size	L		H'		H		T		ID		Bolt Holes #	Shipping Weight iMAG 4700p	
	inch	mm	inch	mm	inch	mm	inch	mm	inch	mm		lbs	Kg
2"	7.9	200	7.8	198	10.8	274	.62	15.7	1.76*	45*	4	21	9.5
3"	7.9	200	8.35	212	12.1	307	.62	15.7	2.68*	68*	4	27	12.3
4"	10.12	257	8.6	218	13.1	332	.62	15.7	3.12	79	8	34	15.5
6"	12.09	307	9.4	239	14.9	378	.69	17.5	5.05	128	8	50	22.5
8"	14.14	359	10.4	264	17.15	435	.69	17.5	6.44	164	8	71	32
10"	18.08	459	11.5	292	19.5	495	.69	17.5	8.61	219	12	130	59
12"	19.68	500	12.5	317	22	559	.81	20.6	10.55	268	12	170	77
Flanges	Standard ANSI 150 lb. drilling											Cable 1 lb.	

Note: 'L' dimension is total from liner face to liner face *Average ID

Install security seals during installation if regulations require.



iMAG Accuracy

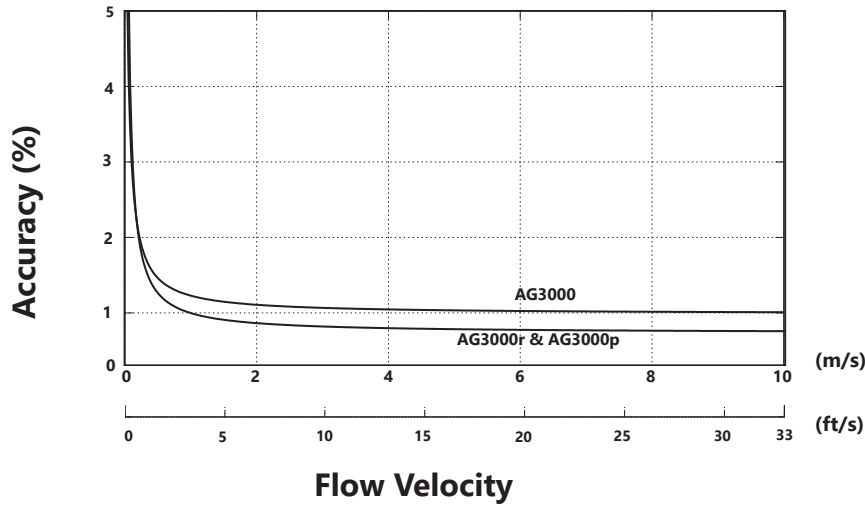

2" & 3" Pressure Drop

Note: No pressure drop in 4" - 12" meters

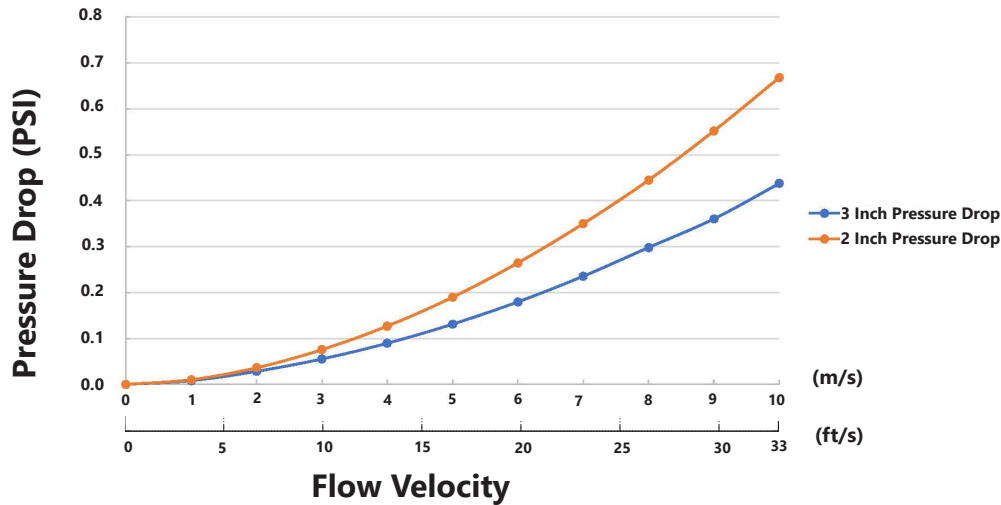

Flow Rate (2" - 12")

Pipe Size (Inches in diameter)	2"	3"	4"	6"	8"	10"	12"
Max Flow Rate (Gallons/Minute)	321	722	1285	2891	5140	8031	11565
Cut-off (min) Flow Rate (Gallons/Minute)	2	4.0	6.43	14.46	25.70	40.15	57.82
Max Flow Rate (Liters/Second)	20.25	46	81	182	324	507	730
Cut-off (min) Flow Rate (Liters/Second)	0.13	0.23	0.41	0.91	1.62	2.54	3.65
Max Flow Velocity (Meters/Second)	10	10	10	10	10	10	10

Straight Pipe Recommendations (X = diameter)

NOTE: These configurations are to be used as general guidelines and do not cover every possible installation. A combination of two or more obstructions will require additional straight pipe. If there is any concern about the length of pipe required for a specific application, please contact your local dealer.

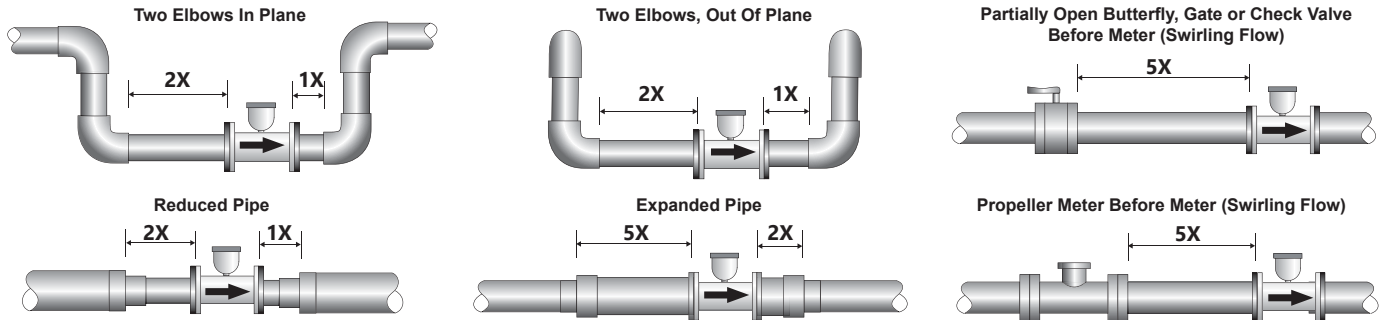

Installing a meter after a pump. Most meters will be installed in systems with some sort of pump, and while the pump is unlikely to have a negative effect on meter performance, there are some situations where understanding the effect the pump has on the flow profile, and by extension on the meter will be of utmost importance.

Air vents should be installed in the same unobstructed pipe run as the meter and should be located relatively close to the meter. Constant bleed air vents are recommended because simple check type air vents will not open once the system is under pressure and an accumulation of air can build up behind them. Significant amounts of air entrained in the flow of water, wildly erratic flow profiles and water that travels through the pipe with significant swirl will cause the meter to read erratically, sometimes very erratically, or not read at all. Therefore, the designer or installer must reduce or eliminate these issues when they are likely to occur.

Every installation is different, but we can offer some general guidelines when it comes to the placement of your pump and meter. And again, in most cases, the pump will have no, or very little effect on the meter's performance, but some care should be taken to assure your installation has the best chance for success.

Confirm there is adequate head to insure a full pipe of water through the meter (a valve downstream of the meter may be required).

Vertical Turbine Pumps drawing from deep wells, or from well under the surface of the water will generally have very little effect on the flow profile of the water by the time the water reaches the meter.

Short Coupled Lift Pumps can, but will not necessarily, cause an erratic or swirling flow profile. Care must be taken during system layout to avoid these issues. The inlet of these pumps will be located near the surface of the water supply and can both suck air from the surface and swirl the water around the pump. This swirling water itself may be a contributing factor of poor flow profile and also lower the surface of the water over the pump inlet.

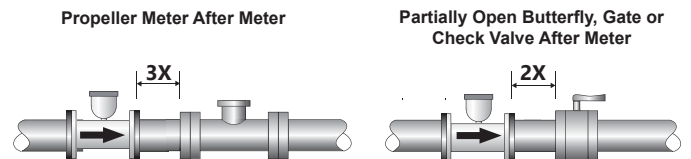

The absolute minimum depth of the inlet of the pump can be calculated using this formula,

$$S = D + (0.574Q/D^{1.5})$$

Where
 S=Submergence in inches
 D=Pump bell diameter in inches
 Q=Flowrate in gallons per minute

Note: to raise D to the power of 1.5 (3/2) as shown in $D^{1.5}$ Take the square root of D and cube the result.

Be sure to calculate from the minimum water level during all seasons of pump operation.

If the water supply will be located in a confined area such as canal turn out, and especially if the turnout ends in a cylindrical vault, the motion of the pump can result in significant swirl of the water being sucked through the pump and this will cause the meter to perform poorly. Be sure to take steps to keep the water from swirling or meter performance will be affected.

Booster Pumps before the meter can also cause swirl or an erratic flow profile. If a booster pump is located before the meter, it must be located far enough upstream that the flow profile has a chance to return to normal. Every case will be different, but we recommend a minimum of at least 10 pipe diameters after the booster pump and before the meter. By the very nature of their purpose, booster pumps will also cause low pressure in the pipe upstream of the pump. If this low pressure falls low enough, it may open any air vent upstream of the pump which will cause air to enter the water stream. In this case, the entrained air will likely cause the meter to go into an empty pipe state.

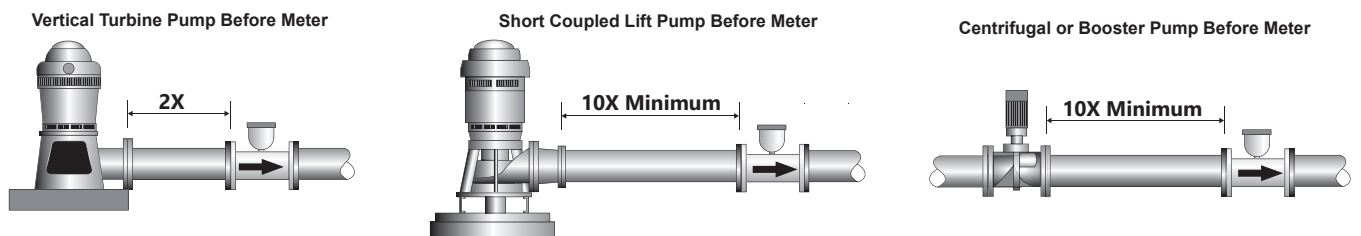

Full Pipe Recommendations

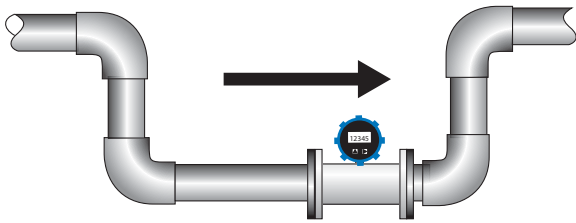

Recommended:
Keep pipe full at meter for accuracy

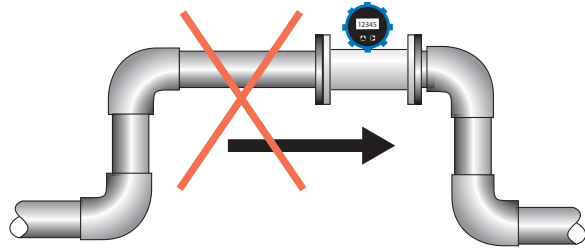

Not Ideal:
Allows air pockets to form at meter

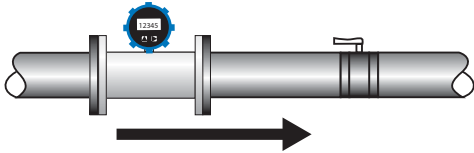

Recommended:
Keeps pipe full at meter for accuracy

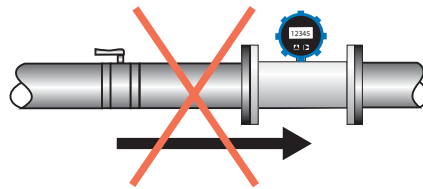

Not Ideal:
Post-valve cavitation can create air pocket

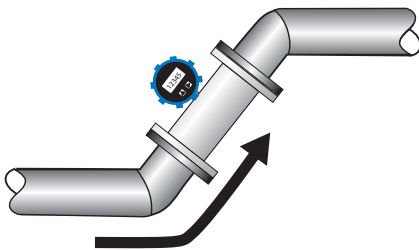

Recommended:
Allows air to bleed off

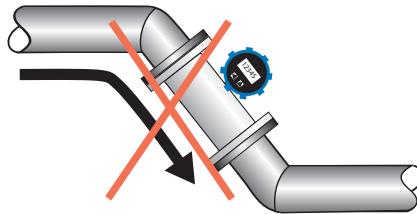

Not Ideal:
Air can be trapped

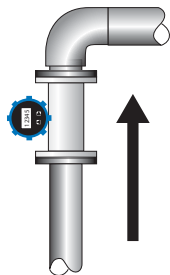

Recommended:
Allows air to bleed off

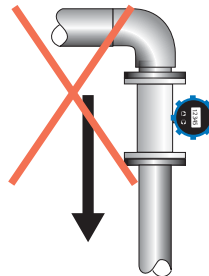

Not Ideal:
Air can be trapped

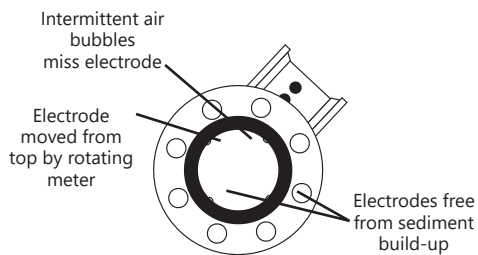

Recommended:
Improved accuracy results from unimpeded electrodes

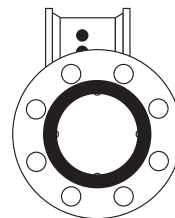

Not Ideal:
Air bubbles and sediment on the electrodes can affect accuracy

Positioning the Meter



CAUTION: These flow sensors are not recommended where installation may expose the flow sensor to boiler pressure and temperature. Maximum recommended operating temperature is 140° F (60° C).
ATTENTION: Ces capteurs de débit ne sont pas recommandés là où l'installation peut exposer le capteur de débit à la pression et à la température de la chaudière. La température de fonctionnement maximale recommandée est de 140° F (60° C).

These meters can be installed horizontally, vertically (with upward flow), and in any radial position. **Using a check valve on the upstream side of the meter, and/or an air vent (vacuum relief valve) in the same, unobstructed run of pipe as the meter, is required in any installation where the meter may be exposed to suction when the system is not in normal operation. Suction can cause damage to the liner. Liner damage caused by suction, without the use of a check valve and/or air vent, may void the warranty.**

Straight Pipe Recommendations. The iMAG requires straight pipe before and after the meter for best accuracy. However, the ability of electromagnetic meters to average the flow across the entire pipe allows for shorter straight pipe recommendations than most mechanical meters (see page 7).

Full Pipe Recommendations. To prevent false readings, this meter is designed to indicate 'EMPTY PIPE' if one or more electrodes is exposed. For highest accuracy, install the meter so that the pipe will be full when there is flow. If air bubbles may be present in the pipe or sludge accumulation is an issue, rotate the meter by one flange hole to position the control housing at a 45° angle (see diagrams on page 8).

Fittings. The iMAG has ANSI 150 lb. drilled flanges and will mate with any other ANSI 150 lb. flanges. See table on page 10 for flange bolt tightening torque specifications.

Calibration. The iMAG is factory-calibrated before shipping. The frequency of recalibration will depend on the needs of each application and local regulatory policies.

Chemical Injection. When the iMAG is used in a chemical injection application, **the chemical injection point must be placed downstream of the magmeter OR far enough upstream for complete mixing to occur before the fluid reaches the meter.** When unmixed chemical alternates with water passing through the meter, the rapid changes in conductivity may cause sudden spikes and drops in the meter's reading, resulting in inaccurate measurement. The magmeter will restabilize, however, with a steady flow of fluid of uniform conductivity.



CAUTION: In chemical injection applications, install chemical injection point downstream of magmeter, or far enough upstream to allow complete mixing of fluids.
ATTENTION: dans les applications d'injection de produits chimiques, installez le point d'injection de produits chimiques en aval du débitmètre électromagnétique ou suffisamment en amont pour permettre un mélange complet des fluides.



NOTICE: Do not install a magmeter downstream of a pressure or proportional control valve.
AVIS: N'installez pas de débitmètre magnétique en aval d'une vanne de régulation de pression ou proportionnelle.

Installing Gaskets



NOTICE: Gaskets are required at all junctions.
AVIS: Des joints sont requis à toutes les jonctions.

1. Be sure all mating surfaces are smooth and free of debris.
2. Install Seametrics provided gaskets, or equivalent, on each end of meter as shown in diagrams below. If using grounding rings, install one gasket on each side of the grounding ring.
3. **Failure to install gaskets will void warranty.**

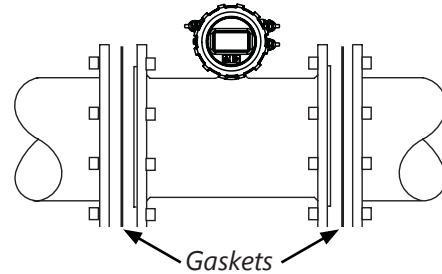

Installation without grounding rings

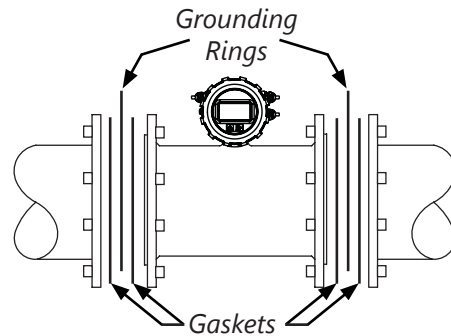

Installation with grounding rings

Tightening Flange Bolts

NOTE: Mating pipe flanges must be ANSI 150# full face (FF) and/or raised face (RT).

1. Tighten flange bolts in an alternating pattern.
 - Tighten left flange bolt-1 to 20% recommended torque.
 - Tighten right flange bolt-1 to 20% of recommended torque.
 - Repeat steps a and b for each bolt in an alternating order, such as shown at right, tightening to 40%, then 60%, then 80%, and then 100%.
2. Test for leaks.
3. If needed, tighten further in 10% increments until leaking stops. **DO NOT over-tighten. Over-tightening can cause serious damage to the flow meter.**
4. Recheck after 24 hours, adjusting if needed.

SUGGESTED FLANGE BOLT TORQUE

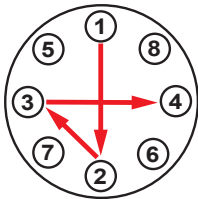

Suggested Tightening Sequence

Pipe Size	Liner	
	ft-lb	Nm
2"	18	25
3"	25	34
4"	20	27
6"	42	57
8"	65	88
10"	73	99
12"	97	132



CAUTION: Improper tightening sequence can cause serious damage to the flow meter.

- Do not tighten one side at a time.
- Do not tighten each bolt completely at one time.

ATTENTION: Une séquence de serrage incorrecte peut endommager gravement le débitmètre.

- Ne serrez pas un côté à la fois.
- Ne serrez pas complètement chaque boulon en une seule fois.

Equalization and Grounding



WARNING: ELECTRICAL SHOCK HAZARD

When the iMAG is installed in a plastic piping system, or when externally powered, the piping system must be grounded to meet national and local electrical safety codes. Failure to do so can result in electrocution.

AVERTISSEMENT: RISQUE D'ÉLECTROCUTION

Lorsque l'iMAG est installé dans un système de tuyauterie en plastique, ou lorsqu'il est alimenté de manière externe, le système de tuyauterie doit être mis à la terre pour respecter les codes de sécurité électriques nationaux et locaux. Ne pas le faire peut entraîner une électrocution.

Metal Pipe Installations. To equalize the electrical potential of the fluid, the meter, and the surrounding pipe, secure the flange plates (factory-installed on the equalization wire) to both pipe flanges at one of the bolt holes, as shown below.

Be sure the lock washer fits between the pipe flange and the flange plate. For the best electrical bonding, remove rust and paint to expose clean, bare metal where the equalization flange plate lock washer contacts the pipe flange. Connection must be inspected periodically for corrosion to maintain the necessary low resistance connection.

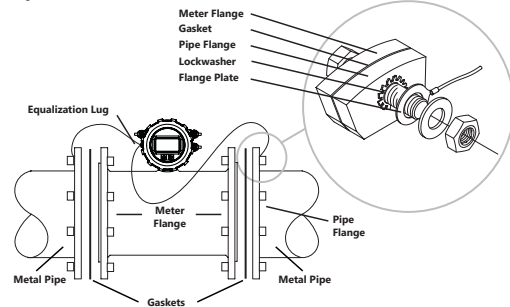

Plastic Pipe and Electronically Noisy Installations. When the meter is installed in plastic pipe or in an electrically noisy system (near a VFD etc.), grounding rings are recommended. As shown in the diagram below, the equalization wires should be solidly connected to the grounding ring tabs instead of the flange bolts as in metal piping installations. Where lightning is a threat, or in severe electrical environments, an optional connection to a nearby equipment ground or ground rod may be advisable.

Grounding Ring Part Numbers:

- 2" = 104124 6" = 100877
- 3" = 102157 8" = 100878
- 4" = 100876 10" = 100879
- 12" = 103288

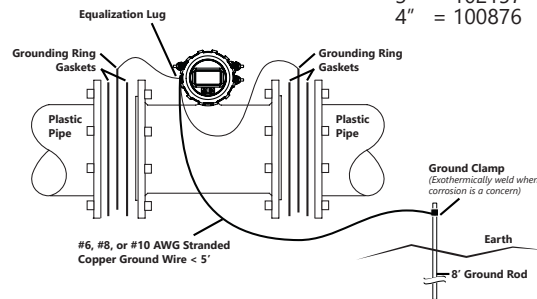

Although grounding rings will not be necessary on all installations, adding grounding rings to any meter at the time of installation will make the diagnosis and elimination of excessive noise or transient voltages much easier if found during normal operation of the meter site.

Adding a 5/8" x 8' independent ground rod dedicated to the meter, a ground rod clamp, and connecting them with at least 10 GA ground wire may be necessary when electrical noise is present, but unlike grounding rings, ground rods are easy to add after the fact although installing these during meter installation adds insurance that a meter will encounter less noise and will help protect against large electrical spikes.

Lack of grounding will always cause more problems than grounding loops.

Anytime you work on the meter body or inside the housing, be sure to discharge system pressure prior to working on any part of the meter.

General Cable Information

In the iMAG 4700p meter, there are a maximum of two Power/Output cables that can be installed. These cables contain the wires for any available outputs (scaled pulse, 4-20mA, Modbus®, and Digital) and power (DC or AC). (See Cable Wiring Diagrams and Cable Wiring Table.)

The iMAG 4700p is available in either DC or AC versions.

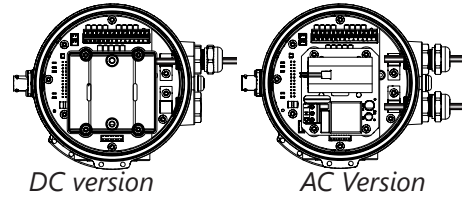
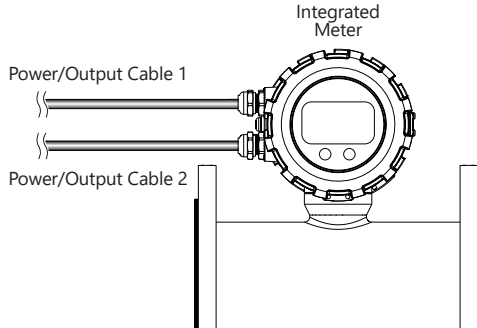

If the meter is configured for AC power the meter will ship with a power cord attached. We do not recommend combining AC power signals with any of the meter outputs in a single cable. If the meter is configured for DC power, you may have one or two cables, depending on configuration. (See Cable Wiring Diagrams.)

Cable Gland Opening and Sealing



NOTICE: Improper sealing of glands or cables will invalidate any warranty. If plugs or cable glands are removed, reinstall using Teflon pipe sealant, or tape, to ensure maximum moisture protection.

AVIS: Une mauvaise étanchéité des presse-étoupes ou des câbles annulera toute garantie. Si les bouchons ou les presse-étoupes sont retirés, réinstallez-les à l'aide d'un scellant pour tuyaux en Téflon ou d'un ruban adhésif pour assurer une protection maximale contre l'humidité.



Remove plug & o-ring. Insert cable gland/strain relief. Feed cable through cable gland.

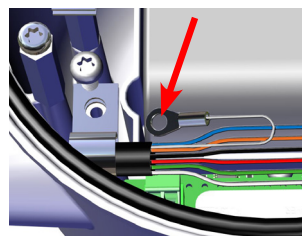

Clamp cable with strain relief clips. If connecting inside a housing, attach drain wire lug to bracket post.

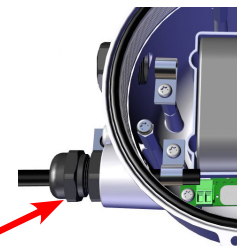

CRITICAL! Torque cable gland sealing nut to 22 in-lbs.

Cable Installation

1. On the back of the meter, unscrew the black user access lid and remove it.

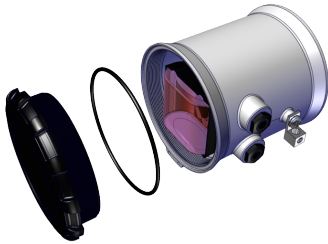

2. Remove the 15 pin screw connector from its bag.
3. Remove the plug and o-ring from the cable port(s) where you want to insert the cable(s).
4. Install cable gland(s) using Teflon pipe sealant, or tape, and insert cable end(s).
5. Strip cable jacket and conductors and install the wires into the 15 pin screw connector in their respective locations for your options, Modbus®, pulse, etc. (See Cable Wiring Table for details.)

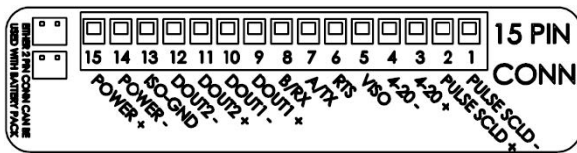

6. If using AC power version continue here. If not, then skip to step 8. If AC then take the red and black wires coming out of the AC supply board and install in POWER+ and POWER- (red wire to pin 15, black wire to pin 14).
7. When the AC power supply board is installed, 100-240VVAC power is supplied via a 3 conductor power cord. If installed outdoors or less than 33ft. (10m) from a utility power service entrance, AC power should be supplied via a properly-grounded surge suppression device.

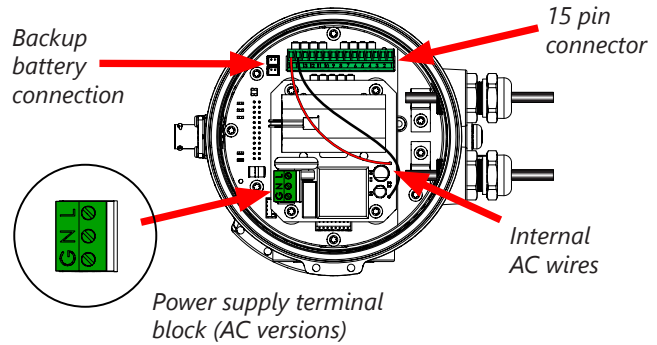

8. Plug the 15 pin screw connector into its socket. **Be sure all pins align properly and that the connector has not slipped to one side.**

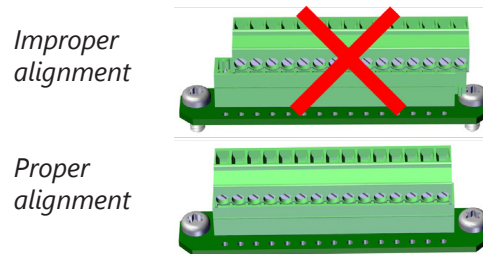

9. **Plug the backup battery cable into either of the two connectors to the left of the 15 pin connector.** (Standard backup batteries are two 3.6V "D" lithium cells. For the AC option, the backup battery is one 9V alkaline cell.)
10. Secure the cables inside the internal strain relief clip and tighten the cable gland sealing nut securely (torque nut to 22 in-lbs). A loose nut could cause moisture ingress and compromise the meter head's IP68 rating, voiding the warranty.
11. Reinstall the user access lid. Be sure to avoid cross-threading the lid and to not pinch any wires with the lid.

Wiring Diagrams

On the back of the meter, unscrew the black user access lid and remove it. Remove the 15 pin screw connector from its bag. Install the wires through the cable glands into the 15 pin screw connector in their respective locations. Plug the 15 pin screw connector into its socket. (C1 = power/output cable 1, C2 = power/output cable 2)

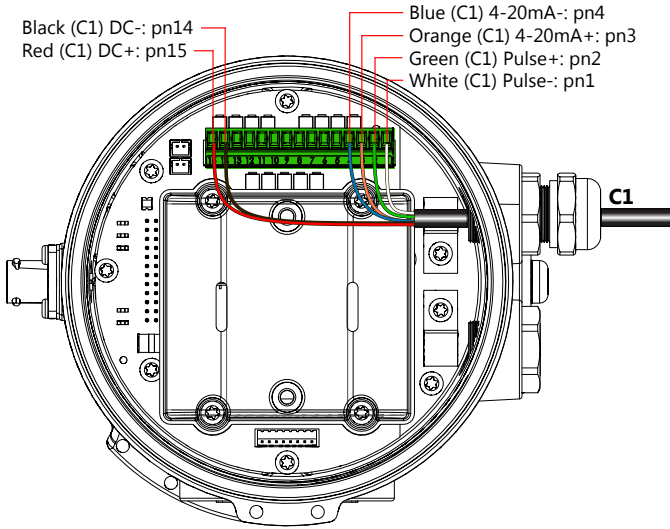

DC Power with Pulse and 4-20mA (D1X/D2X)

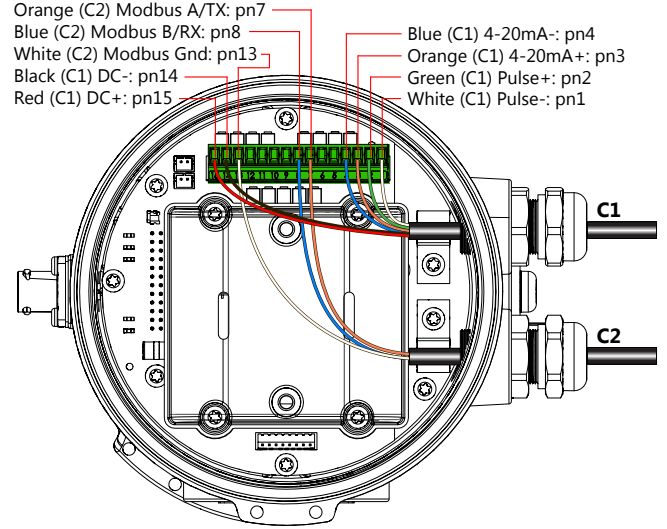

DC Power with Pulse, 4-20mA, and Modbus® (D1S/D2S)

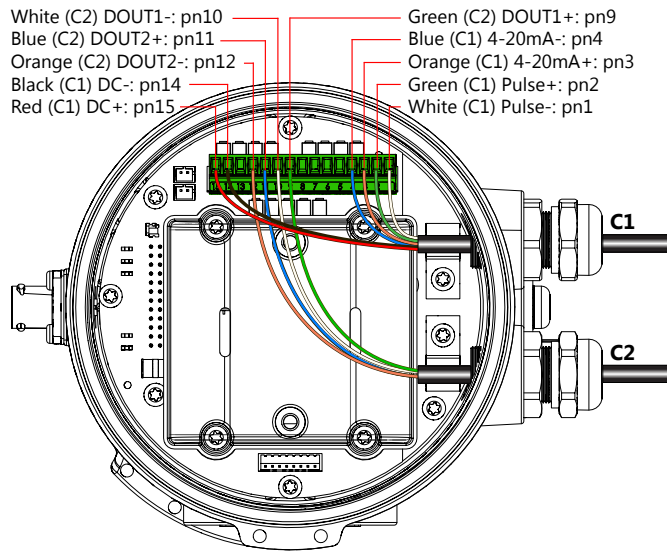

DC Power with Pulse, 4-20mA, and Digital Out (D1G/D2G)

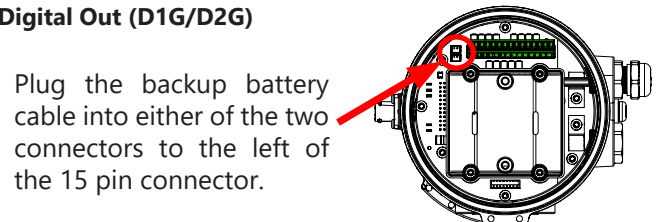
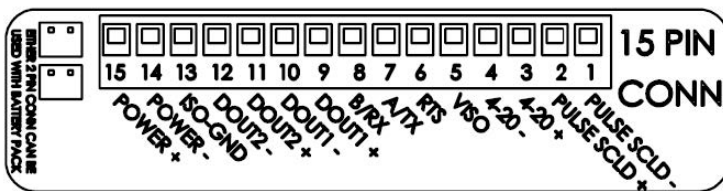

NOTICE: BACKUP BATTERIES ARE NOT INTENDED AS A PRIMARY POWER SOURCE OF A MAINS (DC or AC) CONFIGURED METER.
AVIS: LES PILES DE SECOURS NE SONT PAS CONÇUES COMME SOURCE D'ALIMENTATION PRINCIPALE D'UN COMPTEUR CONFIGURÉ SUR SECTEUR (CC ou CA).

Wiring Diagrams (continued)

On the back of the meter, unscrew the black user access lid and remove it. Remove the 15 pin screw connector from its bag. Install the wires through the cable gland into the 15 pin screw connector in their respective locations. Connect internal black and red wires to pins 14 and 15, respectively. Plug the 15 pin screw connector into its socket. (C1 = power/output cable, AC = AC power cable)

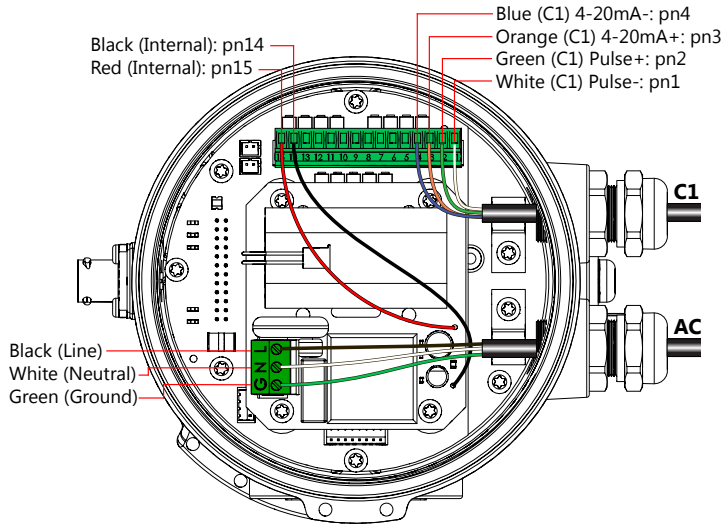

AC Power with Pulse and 4-20mA (A1X/A2X)

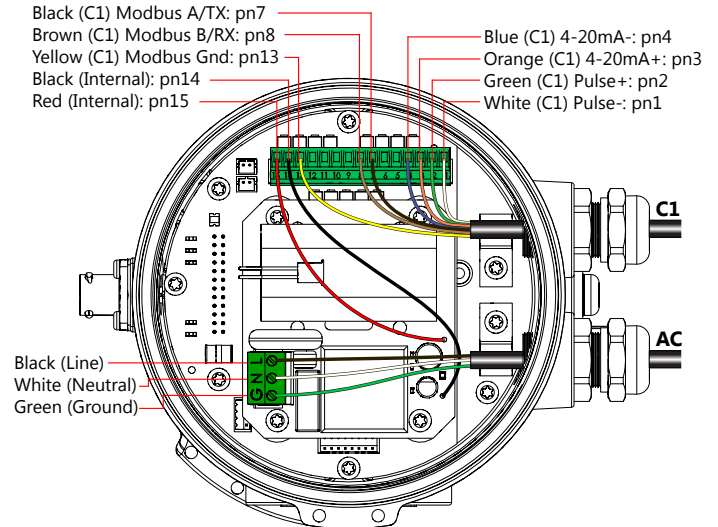

AC Power with Pulse, 4-20mA, and Modbus® (A1S/A2S)

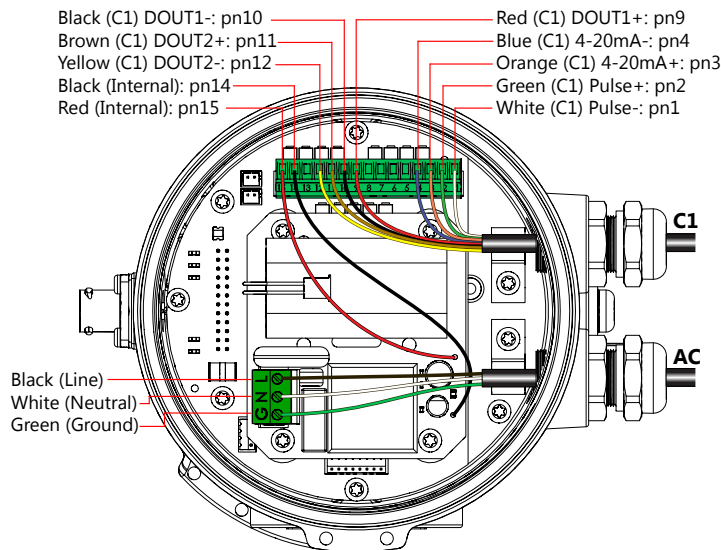

AC Power with Pulse, 4-20mA, and Digital Out (A1G/A2G)

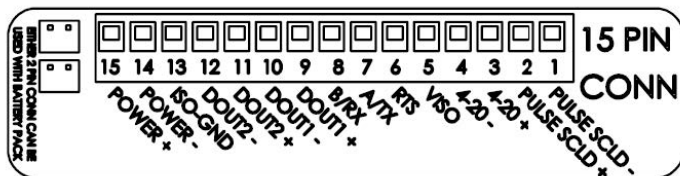
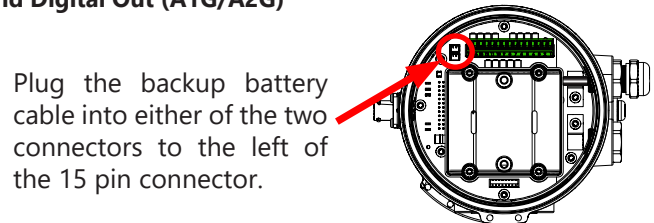

NOTICE: BACKUP BATTERIES ARE NOT INTENDED AS A PRIMARY POWER SOURCE OF A MAINS (DC or AC) CONFIGURED METER.
AVIS: LES PILES DE SECOURS NE SONT PAS CONÇUES COMME SOURCE D'ALIMENTATION PRINCIPALE D'UN COMPTEUR CONFIGURÉ SUR SECTEUR (CC ou CA).

Wiring Diagrams (continued)

Any meter supplied with the Sensus Smart Output option will come with Sensus Smart Output wiring attached to the 15-pin connector. Data logger (RTC) is not an option with the Sensus option. High speed digital output is not available with the Sensus Smart Output option. Any meter supplied with the Data Logger (RTC) option will come with 4-pin Data Logger (RTC) wiring attached. Sensus Smart Output is not available as an option with the Data Logger (RTC) option.

Blue (C1) SENSUS: BLU
 White (C1) SENSUS: WHT
 Brown (C1) SENSUS: BRN

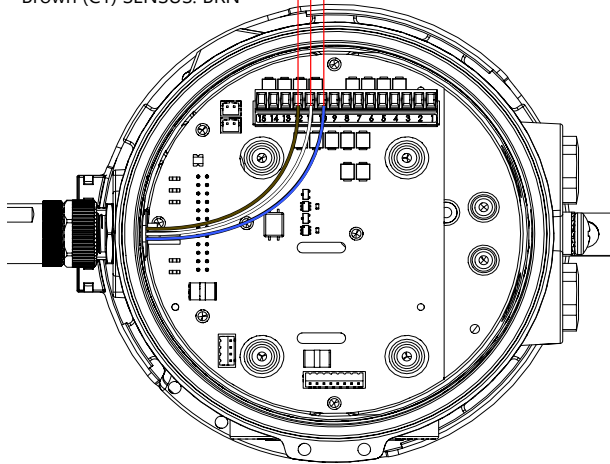

Sensus Smart Output

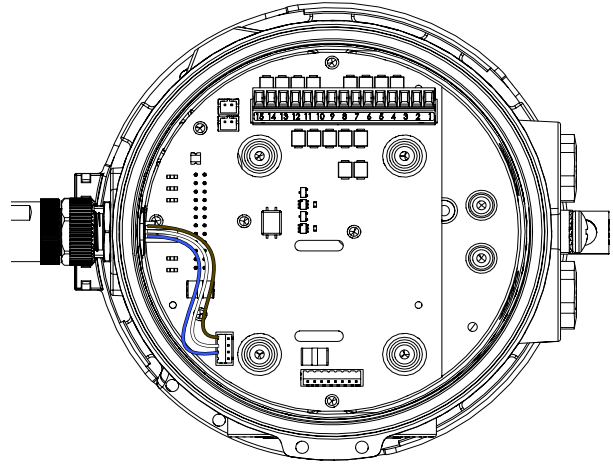

Data Logger (RTC)

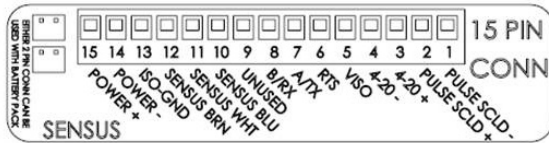

Cable Wiring Table

PIN	15	14	13	12	11	10	9	8	7	6	5	4	3	2	1
O ID	PWR+	PWR-	ISO-GND	DOUT 2-	DOUT 2+	DOUT 1-	DOUT 1+	B/RX	A/TX	RTS	VISO	4-20-	4-20+	PULSE SCLD+	PULSE SCLD-
D1X/D2X	RED C1	BLACK C1										BLUE C1	ORNG C1	GREEN C1	WHITE C1
D1S/D2S	RED C1	BLACK C1	WHITE C2					BLUE C2	ORNG C2			BLUE C1	ORNG C1	GREEN C1	WHITE C1
D1G/D2G	RED C1	BLACK C1		ORNG C2	BLUE C2	WHITE C2	GREEN C2					BLUE C1	ORNG C1	GREEN C1	WHITE C1
A1X/A2X	RED INT	BLACK INT										BLUE C1	ORNG C1	GREEN C1	WHITE C1
A1S/A2S	RED INT	BLACK INT	YELLOW C1					BROWN C1	BLACK C1			BLUE C1	ORNG C1	GREEN C1	WHITE C1
A1G/A2G	RED INT	BLACK INT		YELLOW C1	BROWN C1	BLACK C1	RED C1					BLUE C1	ORNG C1	GREEN C1	WHITE C1
Sensus				Brown EXT	White EXT	Blue EXT									

(C1 = power/output cable 1 C2 = power/output cable 2 INT = Internal AC power wires) EXT = Sensus/ Data Logger Connector

Option IDs

- O ID** **POWER SOURCE / OUTPUT(S)**
- D1X/D2X** = DC POWER / PULSE SCALED AND 4-20mA
- D1S/D2S** = DC POWER / PULSE SCALED, 4-20mA, AND MODBUS[®]
- D1G/D2G** = DC POWER / PULSE SCALED, 4-20mA, AND DIGITAL
- A1X/A2X** = AC POWER / PULSE SCALED AND 4-20mA
- A1S/A2S** = AC POWER / PULSE SCALED, 4-20mA, AND MODBUS[®]
- A1G/A2G** = AC POWER / PULSE SCALED, 4-20mA AND DIGITAL

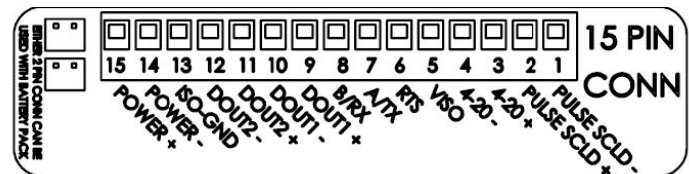

Pulse or Digital Output Application - Sourcing Mode (Recommended for $R_{in} < 30k\Omega$)

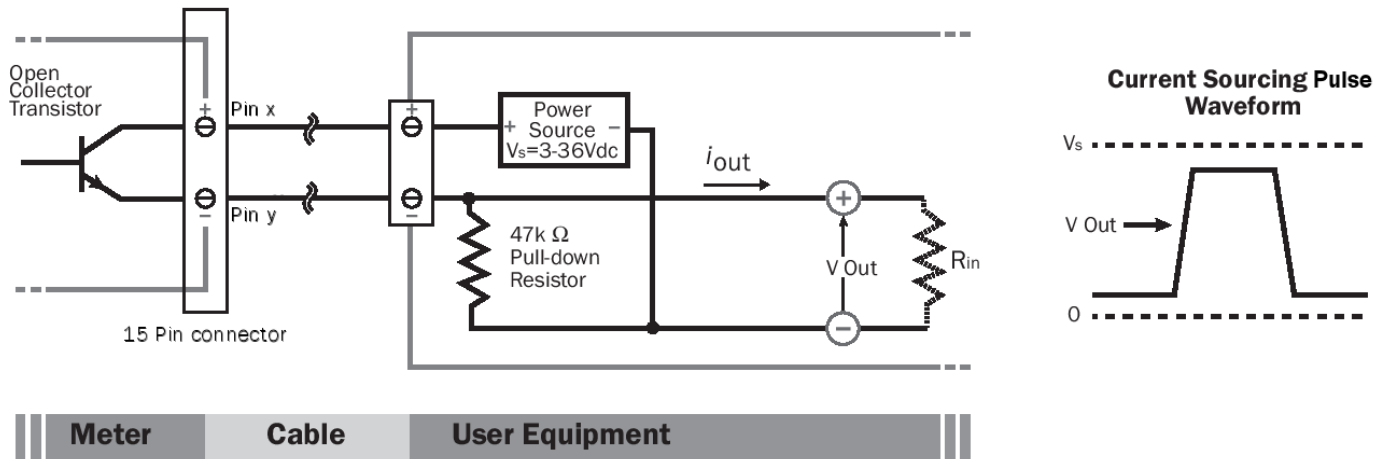

Pulse or Digital Output Application - Sinking Mode (Recommended for $R_{in} > 30k\Omega$)

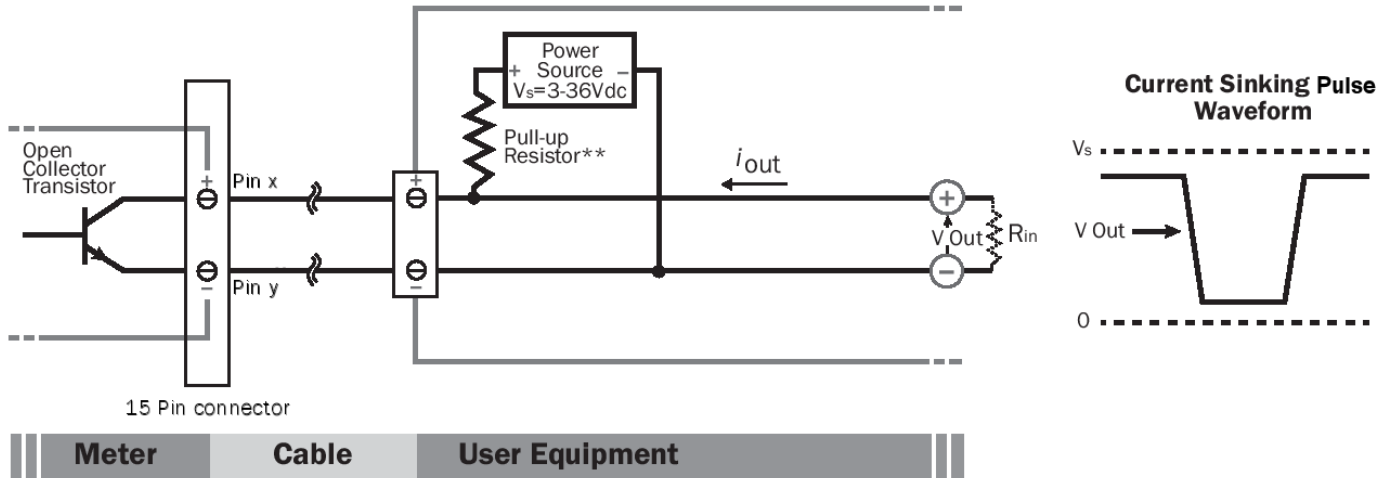

Analog (4-20mA Current Loop) Output Application

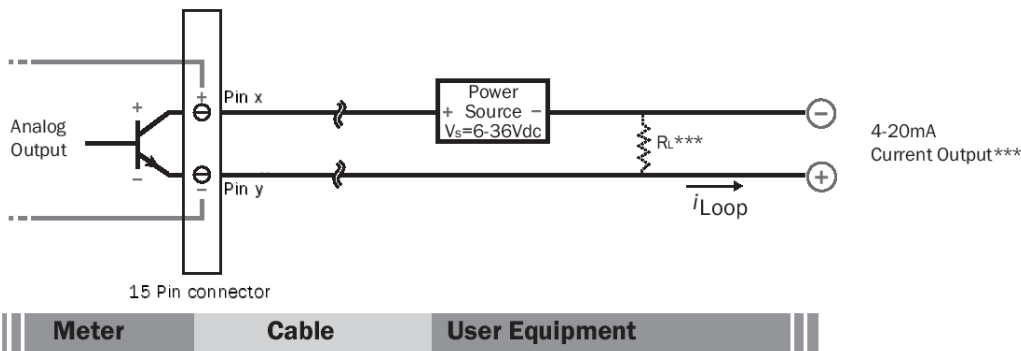

** Minimum resistor value is $(100 \times V_s)$ ohms. Higher resistances maybe used depending on frequency and cable length. Longer cables and high frequencies require lower resistance.

*** Resistor R_L converts 4-20mA current to voltage for voltage input only devices.

Cable Shield. The cable shield and its bare drain wire should be connected at one end, but not both. Best practice is to connect the drain wire to an isolated ground at, or in, the user's equipment in order to drain off errant signals and electrical noise.

Pulse Output Configuration. A pulse output is standard on all models. Since this is an isolated output, the external equipment must include a DC power source to regenerate the pulse from the open-collector output (transistor equivalent of a contact closure). A pull-up or pull-down resistor may be needed if not included in the user equipment as shown in the diagrams. Both the power source and resistor may be supplied internally in some types of control and monitoring devices. If not, as for most PLC discrete input modules, they must be added externally at the module input terminals. The pulse output rate in volume units/pulse can be set by the user via the SETP tab on the meter's setup menus.

Because the pulse output of an iMAG 4700 meter is set by the user, care must be taken to assure the output pulses do not exceed the maximum frequency of the meter while also ensuring a reasonable resolution. The iMAG 4700p has a maximum pulse output of 200 Hz

K-factor: Remember that SETP is expressed in units totaled per output pulse (G/P if using gallons) while K-factors are expressed in pulses per gallon (P/G.) To determine K-factor from SETP, divide 1 by SETP (if SETP is expressed in gallons.) Conversely, 1 divided by the K-factor equals SETP

Because all pulse outputs (SETP) are configured in (rate) units totaled per pulse, all sizes of meters can be configured with the same SETP values

For example, if your rate is chosen as gallons per minute (GPM) the table below applies. If your rate is different, simply use your rate label in place of (GPM.) The numerical values will remain the same.

Pulse Units. The units of measure of SETP are independently selectable and are not tied to rate or total. Upon change of the SETP unit, the pulse output may take up to 10 seconds, or the duration of one pulse (whichever is longer) to take effect.

If Pulse Output is Inconsistent. The PDAMP filter may need to be increased.

Pulse Width Timing. The unit and value of SETP must be chosen to keep the duration between meter pulse outputs to less than 500 seconds.

SETP	Flow Rate at 1 Hz (GPM)	Flow Rate at 200 Hz (GPM) <i>Powered Meters</i>	Flow Rate at 150 Hz (GPM) <i>Battery Powered Meters</i>
0.1	6	1200	900
0.2	12	2400	1800
0.3	18	3600	2700
0.4	24	4800	3600
0.5	30	6000	4500
0.6	36	7200	5400
0.7	42	8400	6300
0.8	48	9600	7200
0.9	54	10800	8100
1.0	60	12000	9000

Lower frequency output pulses (1 pulse for some particular number of gallons) can also be set.

Any output frequency can be determined by:

$$\text{Rate (units/minute)} \div \text{SETP (units/pulse)} = \text{pulse/minute}$$

$$\text{Hz} = \text{pulse/minute} \div 60 \text{ seconds / minutes}$$

Analog Output (4-20mA) Configuration. Since the meter’s analog output is isolated and passive, loop power must be supplied externally as shown on previous page. (In addition, an external resistor R_L will be needed to convert the loop current to voltage for voltage-only input devices.) The meter’s loop transmitter minimum voltage drop is 6Vdc which, with wiring resistance and loop power supply voltage, will determine the maximum resistance for R_L . The flow rates corresponding to 4 and 20mA can be set by the user via the SET 4 and SET20 tabs on the meter’s setup menus.

Note: As configured by the factory, any alarm state will force 22.8mA on the loop. This can be changed to 3.2mA - see Technical Bulletin, 'iMAG4700/AG3000: Changing the 4-20mA Alarm'.

Modbus® Serial Communication Configuration (factory configured). These connections provide a half-duplex, isolated, RS485 serial communications port using the Modbus messaging protocol. The port is reconfigurable by internal jumper settings to full-duplex RS232 or 3.3V CMOS (See Seametrics Modbus Interface Description manual for instructions). The TXD connection is the transmitted data output from the meter and RXD is the received data input to the meter. See Seametric’s Modbus Interface Description, LT-103393 (available at www.seametrics.com) for supported Modbus message protocol and electrical interface specifications.

Digital Output (High Frequency) Configuration. These outputs are electrically similar to the Pulse Output described above except they are capable of output frequencies up to 10kHz. The frequency output scaling can be set by the user via the SETF tab on the meter’s setup menus. Selections are: 500Hz and 1, 2, 5 and 10 KHz at maximum flow rate.

DOUT1 Pulses in forward direction

DOUT2 Pulses in reverse direction

K-Factors for High Speed Digital Output (High Frequency)

Size	SETF (Hz)				
	500	1K	2K	5K	10K
3"	41.55	83.10	166.2	415.51	831.02
4"	23.35	46.69	93.39	233.5	466.9
6"	10.38	20.75	41.51	103.8	207.5
8"	5.837	11.67	23.35	58.37	116.7
10"	3.736	7.471	14.94	37.36	74.71
12"	2.594	5.188	10.38	25.94	51.88

Changing Flow Meter Settings

Home Screen and General Navigation

The HOME Screen displays flow volume, direction of the flow total and flow RATE along with status conditions such as Empty Pipe. Two buttons below the LCD display are used to access menu screens for viewing and changing meter setup parameters.

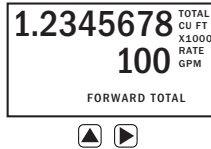

These two buttons are light sensors which can detect when a finger is covering them and activate upon release. Only three button touch actions are needed to control navigation through the menus, settings changes and back to the home screen.

HORIZONTAL SCROLLING:

Tap right button to scroll horizontally through menu tabs or move horizontally within a tab dialog when applicable.



SELECT:

Tap left button to change a highlighted item within a tab dialog.



ENTER/EXIT:

Hold left button while tapping right button once to enter or exit a tab dialog or to navigate between the HOME and other menu screens.



Changing Total Direction/Resetting Batch Totalizers

On the Main screen, hold right button and tap left button 5 times to scroll through the total direction options. Release right button to select a total direction.



Once BATCH FORWARD or BATCH REVERSE is selected, tap right button four times to reset batch totalizer.

Entering Menu System

To enter the Menu System perform the hold and tap sequence. The Passcode entry screen will display. The default passcode is 000000. If a different passcode has previously been set, use the up and right buttons to enter that passcode. In either case, hold and tap again to move into the menu system. (If you enter the wrong passcode, hold and tap again to return to the previous screen. See page 21 for information on how to change a passcode.)

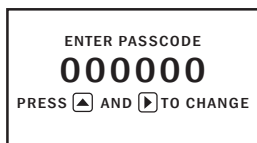

Making Selections

Once in the Menu System, move from tab to tab by tapping the right button. (See the next page for details on the various available tabs.)



Select the parameter. In the screen for the highlighted tab you will see the current parameter value for that tab. Tapping the right button, move to the tab for the parameter you want to change.



In this example, the first line indicates that the current unit for the TOTAL is GALLONS. The next two lines tell you what to do next.

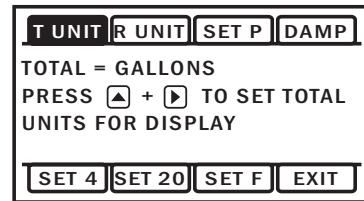

If you would like to change the TOTAL units, just perform the hold and tap sequence to bring up a screen to change the setting.

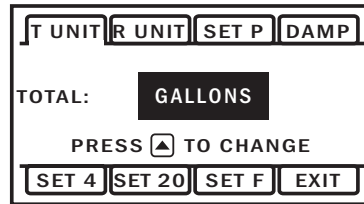

Select a new setting. Select the new setting by scrolling through a list of selections as in the screen illustration below by tapping the left button to find a different TOTAL unit.



Accept changes. To accept any changes you have made, perform the hold and tap sequence.



When finished making changes. When you are finished making changes, move to the EXIT tab using the right button.



To return to the HOME screen, perform the hold and tap sequence.



Standard Menu Options

Note: Available options will depend on specific meter configuration. Not all options are available on all meters.

Options not ordered with your meter will not appear on the meter menu.

T UNIT

View or change TOTAL volume units

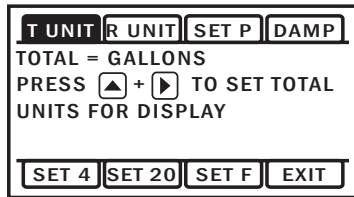

SET 4

View or change flow rate corresponding to 4mA.

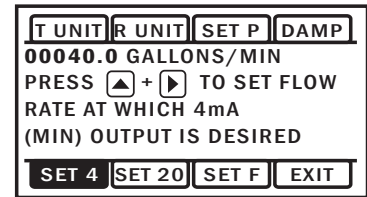

R UNIT

View or change flow RATE units

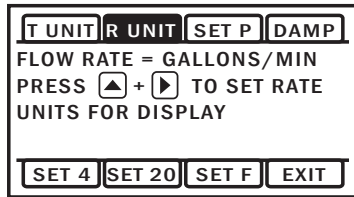

SET 20

View or change flow rate corresponding to 20mA.

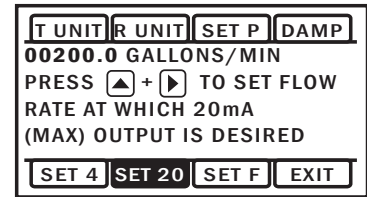

SET P

View or change pulse output scaling

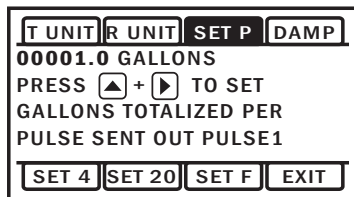

SET F

View or change high frequency output scaling.

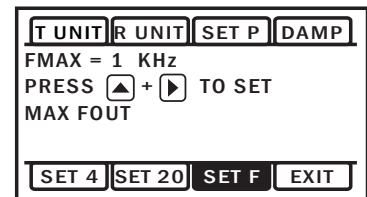

DAMP

View or change # of samples for rolling average.

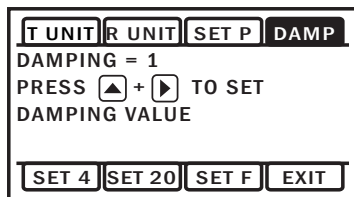

EXIT

Return to HOME SCREEN or enter SUBMENU

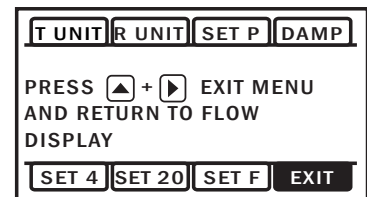

Special SUBMENU for Further Options

The EXIT tab in the MAIN MENU has a second function. If, instead of using the hold and tap sequence to return to the HOME screen, you tap [UP] five times, you will be redirected to a SUBMENU screen from which you can access several more options.

Navigation in this SUBMENU is the same as for the MAIN MENU. Whenever you wish, go to the EXIT tab in the SUBMENU and perform the hold and tap sequence to return to the MAIN MENU.

INFO: Meter model number, serial number, and firmware version.

COMM: Modbus® baud rate and parity.

MBID: Modbus® address

EXIT: Return to MAIN MENU.

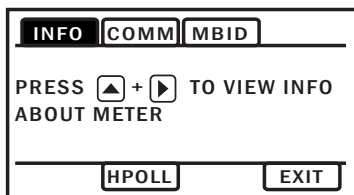

Sub-Menu

To Change a Passcode and Decimal Places

The iMAG has a passcode system for restricting access to the menus. The iMAG comes from the factory with the passcode set to 000000. When a user attempts to enter the menu system (see details on page 19), the passcode entry screen will be displayed.



The default passcode is 000000. If a different passcode has previously been set, then the user must enter that passcode at this time. After entering the passcode, or leaving it at 000000 if using the default passcode, the user does the tap and hold sequence to move into the menu system.

To change the passcode, you must use the THIRD MENU screen. Access the THIRD MENU screen as follows:

- Enter the main menu system, as described above.

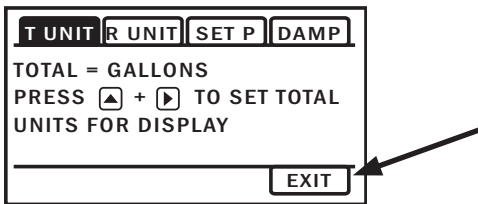

- On the main menu, tab over to the EXIT tab and tap the up arrow five times. A SUBMENU screen will display.

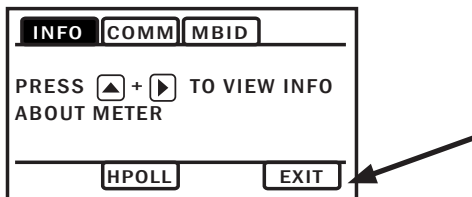

- On the SUBMENU screen tab over to the EXIT tab and tap the up arrow five times. The THIRD MENU screen will display.

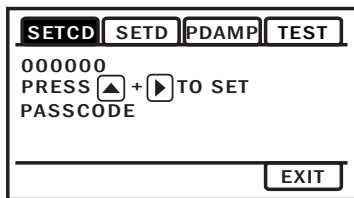

- To set the passcode, hold and tap and then use the [up arrow] and [right arrow] to enter the new code.
- Hold and tap again to return to the THIRD MENU screen.
- Tab to EXIT, and then hold and tap to return to the SUBMENU.

To change the number of decimal places in the total

- To set the decimal point, hold and tap on SETD and then use the [right arrow] to move the decimal point.
- Hold and tap again to return to the THIRD MENU screen.
- Tab to EXIT, and then hold and tap to return to the SUBMENU.

PLMIN

PLMIN shows the minimum degree of stability required to activate the DAMP filter. 10 would indicate that meter readings that jump more than +/- 90% would not be filtered. Zero indicates that the filters will always be applied.

TEST

TEST allows the user to initiate a fully functional, artificial flow rate for the purpose of testing other connected equipment. When TEST is applied, all features of the meter will function at the stated flow rate (in gallons per second).

For TEST to function, the meter must be filled (not EMPTY PIPE).

To enter a value into the TEST feature, navigate to the TEST tab and enter a flow rate value in the VAL screen (in gallons per second only,) then [right arrow] to the VAL box and [up arrow] to the ON screen. This will initiate the TEST feature. The next [up arrow] would bring you to the OFF screen, but you can 'hold and tap' the arrows to return you to the sub menu while the feature operates.

After use, the TEST feature must be turned OFF. If the TEST feature is not turned OFF, the stated static flow rate (in gallons per second) will be shown any time the meter is full or in a flowing condition. Flow values recorded by the meter while the TEST feature is operating are permanently recorded in the displayed TOTAL. It may be useful to note that these values are only written to permanent memory every 15 minutes and cycling all power within this 15 minute time frame will return the meter to its previous total.

Power Indicators

A power indicator is displayed in the lower left of the main display window.

Any meter powered from an external power source will display a power plug icon when running on external power. If the connection to external power is lost, the meter will switch to the backup battery and the power icon will switch to a battery symbol.

OK on the battery indicator means battery voltage is above 6.4 volts.

LO on the battery indicator means the battery is low and should be replaced soon.



Being powered by external DC or internal AC



Being powered by battery - voltage is sufficient



Being powered by battery - voltage is low

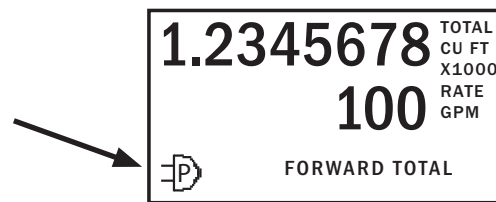

If display reads, 'BATT END' replace battery immediately.

Troubleshooting

Problem	Probable Causes	Things to try...
Blank Display	Faulty wiring from power source to meter Backup battery has not been plugged in Dead backup battery	Check for incorrect wiring. Measure voltage with DMM where red and black wires connect to terminal block TB1 on back side of display. Verify correct polarity and confirm that voltage is steady and between 9Vdc and 32Vdc Plug in the battery Replace battery
Flow rate reading fluctuates excessively when flow is unchanging	Excessively turbulent or unsteady flow due to partially closed valves or other flow obstructions Pipe not full Pulsing flow due to combining multiple upstream flow sources Insufficient mixing of upstream chemicals Low fluid conductivity < 20 μ S/cm Noisy electrical environment Defective or noisy AC switching power supply	Eliminate or minimize causes of flow disturbances or increase meter damping Provide back pressure or other means to ensure pipe is filled Move connection point further upstream Move chemical injection downstream from meter Replace with different type of meter Improve grounding at meter and nearby potentially noisy electrical equipment. Increase distance between meter and electrical noise sources. Replace power supply
Flow Rate appears correct but pulse/ frequency output is low, erratic or absent	Wiring incorrect External device input impedance too low Cable too long	Compare wiring with appropriate wiring recommendations Use sourcing rather than sinking interface connection Reduce interface pull-up resistance
Flow Rate appears correct but pulse/frequency output is erratic and/or too high	Electrical noise sources interfering with pulse frequency signal Wrong type of cable Grounding problem	Isolate, remove or reduce noise sources. Move meter control cable away from noise sources. Increase pulse damp setting (PDAMP) Use only twisted pair cable and ensure both signal wires are on same twisted pair Improve or try different grounding method

Error Messages

Under certain conditions an error message may be displayed.

Message	Description	Notes
INIT	Initialization is occurring during power up.	
EMPTY PIPE	Fluid is not detected between the sensing electrodes.	Loop output = 22.8mA
LO in battery icon	Battery is getting low, replace soon. Meter still functions.	Above 6.4V, OK appears in icon
BATT END	Battery is very low (approx. 6.1V). Totalizer stops updating.	Loop output = 4mA
LOW VOLT	Incoming external power is very low and backup battery is dead or not connected	Loop output = 4mA
COIL FAIL	Coil current too high or too low (short or open).	Loop output = 22.8mA
COMM FAIL	Communication between transmitter and sensor board fails.	Loop output = 22.8mA
OVER RANGE	Rate exceeds number of digits that can be displayed. Adjust units.	Loop output = 4mA

Warning notice system

This manual contains notices you have to observe in order to ensure your personal safety, as well as to prevent damage to property. The notices referring to your personal safety are highlighted in the manual by a safety alert symbol, notices referring only to property damage have no safety symbol. These notices shown below are graded according to the degree of danger.

**WARNING:**

Indicates that death or severe personal injury will result if proper precautions are not taken.

**CAUTION:**

Indicates that minor personal injury may result if proper precautions are not taken.

**NOTICE:**

Indicates that an unintended result or situation can occur if the corresponding information is not taken into account.

If more than one degree of danger is present, the warning notice representing the highest degree of danger will be used. A notice warning of injury to persons with a safety alert symbol may also include a warning relating to property damage.

Qualified personnel

The product/system described in this documentation may be operated only by personnel qualified for the specific task in accordance with the relevant documentation for the specific task, in particular its warning notices and safety instructions. Qualified personnel are those who, based on their training and experience, are capable of identifying risks and avoiding potential hazards when working with these products/systems.

Proper use of Seametrics products

Seametrics products may only be used for the applications described in the catalog and in the relevant technical documentation. If products and components from other manufacturers are used, these must be recommended or approved by Seametrics. Proper transport, storage, installation, assembly, commissioning, operation and maintenance are required to ensure that the products operate safely and without any problems. The permissible ambient conditions must be adhered to. The information in the relevant documentation must be observed.

Trademarks

All names identified by ® are registered trademarks of the Seametrics. The remaining trademarks in this publication may be trademarks whose use by third parties for their own purposes could violate the rights of the owner.

Disclaimer of liability

We have reviewed the contents of this publication to ensure consistency with the hardware and software described. Since variance cannot be precluded entirely, we cannot guarantee full consistency. However, the information in this publication is reviewed regularly and any necessary corrections are included in subsequent editions.

The limited warranty set forth below is given by Seametrics, with respect to Seametrics brand products purchased in the United States of America.

Seametrics warrants that products manufactured by Seametrics, when delivered to you in new condition in their original containers and properly installed, shall be free from defects in material and workmanship. **Seametrics products are warranted against defects for a minimum period of two (2) years from date of installation, unless otherwise specified, with proof of install date. If no proof of install date can be provided, warranty period will be two (2) years from date of shipment from Seametrics, as defined on Seametrics' invoice.** Seametrics' obligation under this warranty shall be limited to replacing or repairing the part or parts, or, at Seametrics' option, the products, which prove defective in material or workmanship. The following are the terms of Seametrics' limited warranty:

- a. Buyer must give Seametrics prompt notice of any defect or failure and satisfactory proof thereof.
- b. Any defective part or parts must be returned to Seametrics' factory or to an authorized service center for inspection.
- c. Buyer will prepay all freight charges to return any products to Seametrics' factory, or another repair facility, as designated by Seametrics.
- d. Defective products, or parts thereof, which are returned to Seametrics and proved to be defective upon inspection, will be repaired to factory specifications.
- e. Seametrics will deliver repaired products or replacements for defective products to the buyer (ground freight prepaid) to the destination provided in the original order.
- f. Products returned to Seametrics for which Seametrics provides replacement under this warranty shall become the property of Seametrics.
- g. This limited warranty covers all defects encountered in normal use of Seametrics products, and does not apply to the following cases:
 - i. Loss of or damage to Seametrics product due to abuse, mishandling, or improper packaging by buyer
 - ii. Failure to follow operating, maintenance, or environmental instructions prescribed in Seametrics' instruction manual
 - iii. Products not used for their intended purpose
 - iv. Alterations to the product, purposeful or accidental
 - v. Electrical current fluctuations
 - vi. Corrosion due to aggressive materials not approved for your specific product
 - vii. Mishandling, or misapplication of Seametrics products
 - viii. Products or parts that are typically consumed during normal operation
 - ix. Use of parts or supplies (other than those sold by Seametrics) which cause damage to the products, or cause abnormally frequent service calls or service problems
- h. A new warranty period will be established for repaired products, or products replaced during the original warranty period.
- i. In the event that equipment is altered or repaired by the buyer without prior written approval by Seametrics, all warranties are void. Damage caused by equipment or accessories not manufactured by Seametrics may void the product's warranty.
- j. SOFTWARE: The Seller grants the user a non-exclusive license to use Seametrics' software, according to the following limitations and conditions:
 - i. The user may install the software on one or more desktop or laptop computers.
 - ii. All title and intellectual rights to the software are owned by Seametrics.
 - iii. No copies may be made or distributed except as described above.
 - iv. The user may not modify or reverse-engineer the software.

THE FOREGOING WARRANTY IS IN LIEU OF ALL OTHER WARRANTIES, WHETHER ORAL, WRITTEN, EXPRESSED, IMPLIED OR STATUTORY. NO IMPLIED WARRANTY, INCLUDING ANY IMPLIED WARRANTY OF MERCHANTABILITY OR FITNESS FOR A PARTICULAR PURPOSE, APPLIED TO THE PRODUCTS AFTER THE APPLICABLE PERIOD OF THE EXPRESS LIMITED WARRANTY STATED ABOVE, AND NO OTHER EXPRESS WARRANTY OR GUARANTY, EXCEPT AS MENTIONED ABOVE, GIVEN BY ANY PERSON OR ENTITY WITH RESPECT TO THE PRODUCTS, SHALL BIND SEAMETRICS. SEAMETRICS SHALL NOT BE LIABLE FOR LOSS OF REVENUES, OR PROFITS, OR INCONVENIENCES, EXPENSE FOR SUBSTITUTE EQUIPMENT OR SERVICE, STORAGE CHARGES, LOSS OF DATA, OR ANY OTHER SPECIAL, INCIDENTAL, OR CONSEQUENTIAL DAMAGE CAUSED BY THE USE OR MISUSE OF, OR INABILITY TO USE THE PRODUCTS, REGARDLESS OF THE LEGAL THEORY ON WHICH THE CLAIM IS BASED, AND EVEN IF SEAMETRICS HAS BEEN ADVISED OF THE POSSIBILITY OF SUCH DAMAGES. IN NO EVENT SHALL RECOVERY OF ANY KIND AGAINST SEAMETRICS BE GREATER IN AMOUNT THAN THE PURCHASE PRICE OF THE PRODUCT SOLD BY SEAMETRICS AND CAUSING THE ALLEGED DAMAGE. WITHOUT LIMITING THE FOREGOING, YOU ASSUME ALL RISK OF LIABILITY FOR LOSS, DAMAGE, OR INJURY TO YOU AND YOUR PROPERTY AND TO OTHERS AND THEIR PROPERTY ARISING OUT OF USE OR MISUSE OF, OR INABILITY TO USE THE PRODUCTS NOT CAUSED DIRECTLY BY THE NEGLIGENCE OF SEAMETRICS.

